



## N-Channel 60-V (D-S) MOSFET

PRODUCT SUMMARY				
Part Number	$V_{(BR)DSS}$ Min (V)	$r_{DS(on)}$ Max ( $\Omega$ )	$V_{GS(th)}$ (V)	$I_D$ (A)
2N7000	60	5 @ $V_{GS} = 10$ V	0.8 to 3	0.2
2N7002		7.5 @ $V_{GS} = 10$ V	1 to 2.5	0.115
VQ1000J		5.5 @ $V_{GS} = 10$ V	0.8 to 2.5	0.225
VQ1000P		5.5 @ $V_{GS} = 10$ V	0.8 to 2.5	0.225
BS170		5 @ $V_{GS} = 10$ V	0.8 to 3	0.5

### FEATURES

- Low On-Resistance: 2.5  $\Omega$
- Low Threshold: 2.1 V
- Low Input Capacitance: 22 pF
- Fast Switching Speed: 7 ns
- Low Input and Output Leakage

### BENEFITS

- Low Offset Voltage
- Low-Voltage Operation
- Easily Driven Without Buffer
- High-Speed Circuits
- Low Error Voltage

### APPLICATIONS

- Direct Logic-Level Interface: TTL/CMOS
- Drivers: Relays, Solenoids, Lamps, Hammers, Displays, Memories, Transistors, etc.
- Battery Operated Systems
- Solid-State Relays

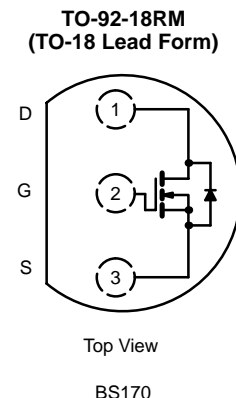
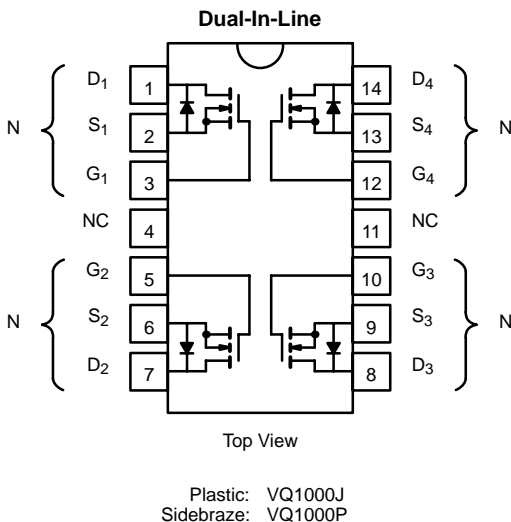
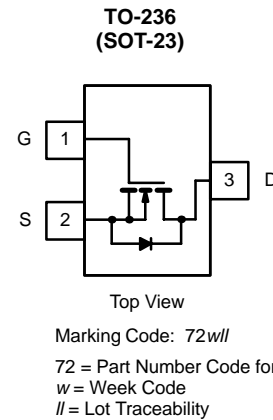
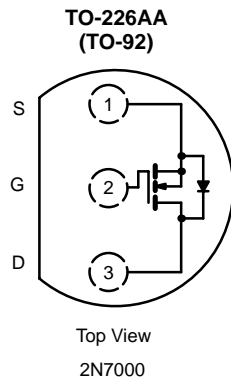



ABSOLUTE MAXIMUM RATINGS ( $T_A = 25^\circ\text{C}$ UNLESS OTHERWISE NOTED)									
Parameter	Symbol	2N7000	2N7002	Single		Total Quad	BS170	Unit	
				VQ1000J	VQ1000P	VQ1000J/P			
Drain-Source Voltage	$V_{DS}$	60	60	60	60		60	V	
Gate-Source Voltage—Non-Repetitive	$V_{GSM}$	$\pm 40$	$\pm 40$	$\pm 30$			$\pm 25$		
Gate-Source Voltage—Continuous	$V_{GS}$	$\pm 20$	$\pm 20$	$\pm 20$	$\pm 20$		$\pm 20$		
Continuous Drain Current ( $T_J = 150^\circ\text{C}$ )	$T_A = 25^\circ\text{C}$	$I_D$	0.2	0.115	0.225	0.225		0.5	A
	$T_A = 100^\circ\text{C}$		0.13	0.073	0.14	0.14		0.175	
Pulsed Drain Current <sup>a</sup>	$I_{DM}$	0.5	0.8	1	1				
Power Dissipation	$T_A = 25^\circ\text{C}$	$P_D$	0.4	0.2	1.3	1.3	2	0.83	W
	$T_A = 100^\circ\text{C}$		0.16	0.08	0.52	0.52	0.8		
Thermal Resistance, Junction-to-Ambient	$R_{thJA}$	312.5	625	96	96	62.5	156	$^\circ\text{C}/\text{W}$	
Operating Junction and Storage Temperature Range	$T_J, T_{stg}$	-55 to 150						$^\circ\text{C}$	

Notes

- a. Pulse width limited by maximum junction temperature.
- b.  $t_p \leq 50 \mu\text{s}$ .

SPECIFICATIONS—2N7000 AND 2N7002 ( $T_A = 25^\circ\text{C}$ UNLESS OTHERWISE NOTED)								
Parameter	Symbol	Test Conditions	Typ <sup>a</sup>	Limits				Unit
				2N7000		2N7002		
				Min	Max	Min	Max	
<b>Static</b>								
Drain-Source Breakdown Voltage	$V_{(BR)DSS}$	$V_{GS} = 0 \text{ V}, I_D = 10 \mu\text{A}$	70	60		60		V
Gate-Threshold Voltage	$V_{GS(th)}$	$V_{DS} = V_{GS}, I_D = 1 \text{ mA}$	2.1	0.8	3			
		$V_{DS} = V_{GS}, I_D = 0.25 \text{ mA}$	2.0			1	2.5	
Gate-Body Leakage	$I_{GSS}$	$V_{DS} = 0 \text{ V}, V_{GS} = \pm 15 \text{ V}$			$\pm 10$			nA
		$V_{DS} = 0 \text{ V}, V_{GS} = \pm 20 \text{ V}$					$\pm 100$	
Zero Gate Voltage Drain Current	$I_{DSS}$	$V_{DS} = 48 \text{ V}, V_{GS} = 0 \text{ V}$			1			$\mu\text{A}$
		$T_C = 125^\circ\text{C}$			1000			
		$V_{DS} = 60 \text{ V}, V_{GS} = 0 \text{ V}$					1	
On-State Drain Current <sup>b</sup>	$I_{D(on)}$	$V_{DS} = 10 \text{ V}, V_{GS} = 4.5 \text{ V}$	0.35	0.075				A
		$V_{DS} = 7.5 \text{ V}, V_{GS} = 10 \text{ V}$	1			0.5		
		$V_{GS} = 4.5 \text{ V}, I_D = 0.075 \text{ A}$	4.5		5.3			
Drain-Source On-Resistance <sup>b</sup>	$r_{DS(on)}$	$V_{GS} = 5 \text{ V}, I_D = 0.05 \text{ A}$	3.2				7.5	$\Omega$
		$T_C = 125^\circ\text{C}$	5.8				13.5	
		$V_{GS} = 10 \text{ V}, I_D = 0.5 \text{ A}$	2.4		5		7.5	
		$T_J = 125^\circ\text{C}$	4.4		9		13.5	
Forward Transconductance <sup>b</sup>	$g_{fs}$	$V_{DS} = 10 \text{ V}, I_D = 0.2 \text{ A}$		100		80		mS
Common Source Output Conductance <sup>b</sup>	$g_{os}$	$V_{DS} = 5 \text{ V}, I_D = 0.05 \text{ A}$	0.5					
<b>Dynamic</b>								
Input Capacitance	$C_{iss}$	$V_{DS} = 25 \text{ V}, V_{GS} = 0 \text{ V}$ $f = 1 \text{ MHz}$	22		60		50	pF
Output Capacitance	$C_{oss}$		11		25		25	
Reverse Transfer Capacitance	$C_{rss}$		2		5		5	



SPECIFICATIONS—2N7000 AND 2N7002 (T <sub>A</sub> = 25 °C UNLESS OTHERWISE NOTED)								
Parameter	Symbol	Test Conditions	Typ <sup>a</sup>	Limits				Unit
				2N7000		2N7002		
				Min	Max	Min	Max	
<b>Switching<sup>d</sup></b>								
Turn-On Time	t <sub>ON</sub>	V <sub>DD</sub> = 15 V, R <sub>L</sub> = 25 Ω I <sub>D</sub> ≅ 0.5 A, V <sub>GEN</sub> = 10 V, R <sub>G</sub> = 25 Ω	7		10			ns
Turn-Off Time	t <sub>OFF</sub>		7		10			
Turn-On Time	t <sub>ON</sub>	V <sub>DD</sub> = 30 V, R <sub>L</sub> = 150 Ω I <sub>D</sub> ≅ 0.2 A, V <sub>GEN</sub> = 10 V, R <sub>G</sub> = 25 Ω	7				20	
Turn-Off Time	t <sub>OFF</sub>		11				20	

SPECIFICATIONS—VQ1000J/P AND BS170 (T <sub>A</sub> = 25 °C UNLESS OTHERWISE NOTED)								
Parameter	Symbol	Test Conditions	Typ <sup>a</sup>	Limits				Unit
				VQ1000J/P		BS170		
				Min	Max	Min	Max	
<b>Static</b>								
Drain-Source Breakdown Voltage	V <sub>(BR)DSS</sub>	V <sub>GS</sub> = 0 V, I <sub>D</sub> = 100 μA	70	60		60		V
Gate-Threshold Voltage	V <sub>GS(th)</sub>	V <sub>DS</sub> = V <sub>GS</sub> , I <sub>D</sub> = 1 mA	2.1	0.8	2.5	0.8	3	
Gate-Body Leakage	I <sub>GSS</sub>	V <sub>DS</sub> = 0 V, V <sub>GS</sub> = ±10 V			±100			nA
		T <sub>J</sub> = 125 °C			±500			
Zero Gate Voltage Drain Current	I <sub>DSS</sub>	V <sub>DS</sub> = 0 V, V <sub>GS</sub> = ±15 V					±10	μA
		V <sub>DS</sub> = 25 V, V <sub>GS</sub> = 0 V					0.5	
		V <sub>DS</sub> = 48 V, V <sub>GS</sub> = 0 V, T <sub>J</sub> = 125 °C			500			
On-State Drain Current <sup>b</sup>	I <sub>D(on)</sub>	V <sub>DS</sub> = 10 V, V <sub>GS</sub> = 10 V	1	0.5				A
		V <sub>GS</sub> = 5 V, I <sub>D</sub> = 0.2 A	4		7.5			
Drain-Source On-Resistance <sup>b</sup>	r <sub>DS(on)</sub>	V <sub>GS</sub> = 10 V, I <sub>D</sub> = 0.2 A	2.3				5	Ω
		V <sub>GS</sub> = 10 V, I <sub>D</sub> = 0.3 A	2.3		5.5			
		T <sub>J</sub> = 125 °C	4.2		7.6			
		V <sub>DS</sub> = 10 V, I <sub>D</sub> = 0.2 A				100		
Forward Transconductance <sup>b</sup>	g <sub>fs</sub>	V <sub>DS</sub> = 10 V, I <sub>D</sub> = 0.5 A		100				mS
Common Source Output Conductance <sup>b</sup>	g <sub>os</sub>	V <sub>DS</sub> = 5 V, I <sub>D</sub> = 0.05 A	0.5					
<b>Dynamic</b>								
Input Capacitance	C <sub>iSS</sub>	V <sub>DS</sub> = 25 V, V <sub>GS</sub> = 0 V f = 1 MHz	22		60		60	pF
Output Capacitance	C <sub>oss</sub>		11		25			
Reverse Transfer Capacitance	C <sub>rSS</sub>		2		5			
<b>Switching<sup>d</sup></b>								
Turn-On Time	t <sub>ON</sub>	V <sub>DD</sub> = 15 V, R <sub>L</sub> = 23 Ω I <sub>D</sub> ≅ 0.6 A, V <sub>GEN</sub> = 10 V, R <sub>G</sub> = 25 Ω	7		10			ns
Turn-Off Time	t <sub>OFF</sub>		7		10			
Turn-On Time	t <sub>ON</sub>	V <sub>DD</sub> = 25 V, R <sub>L</sub> = 125 Ω I <sub>D</sub> ≅ 0.2 A, V <sub>GEN</sub> = 10 V, R <sub>G</sub> = 25 Ω	7				10	
Turn-Off Time	t <sub>OFF</sub>		7				10	

Notes

- a. For DESIGN AID ONLY, not subject to production testing.
- b. Pulse test: PW ≤ 80 μs duty cycle ≤ 1%.
- c. This parameter not registered with JEDEC.
- d. Switching time is essentially independent of operating temperature.

VNBF06

**TYPICAL CHARACTERISTICS ( $T_A = 25^\circ\text{C}$  UNLESS OTHERWISE NOTED)**

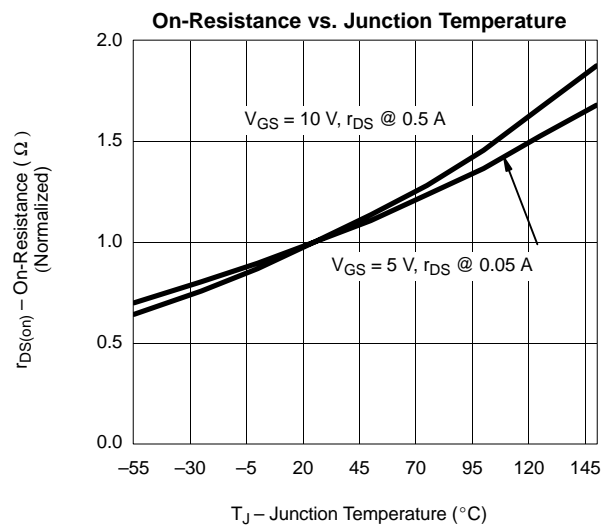
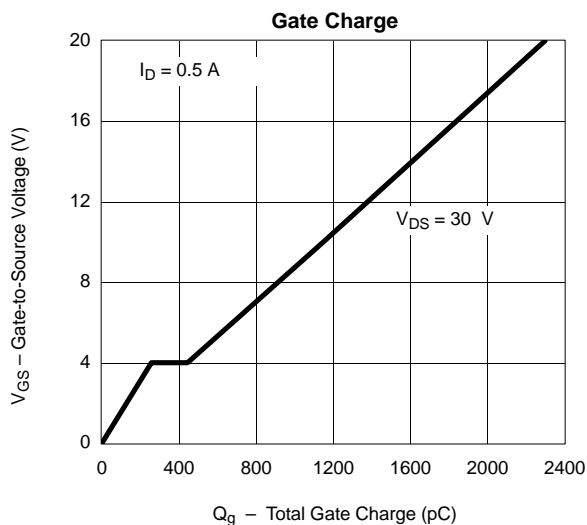
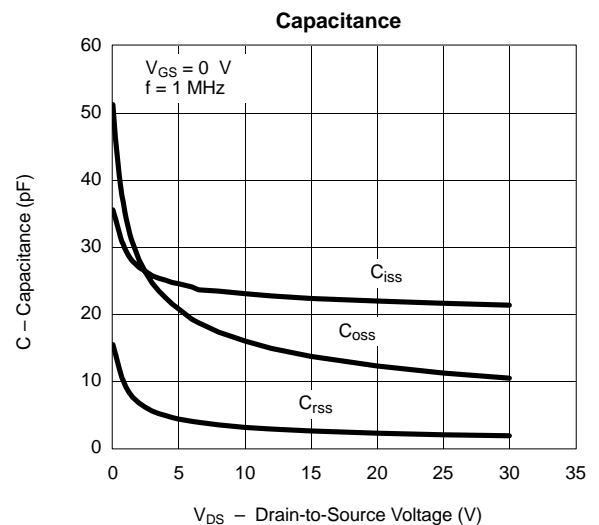
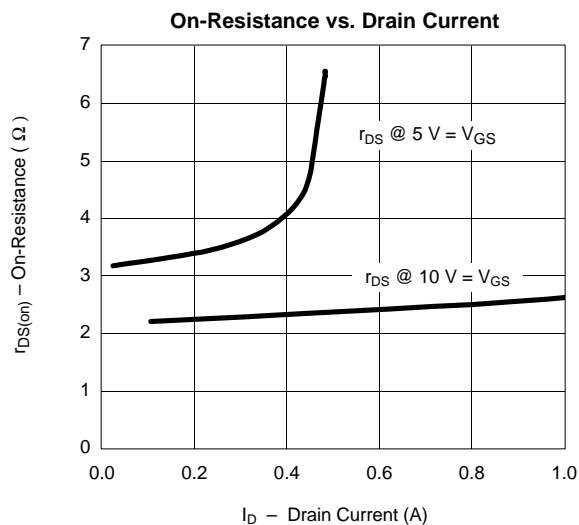
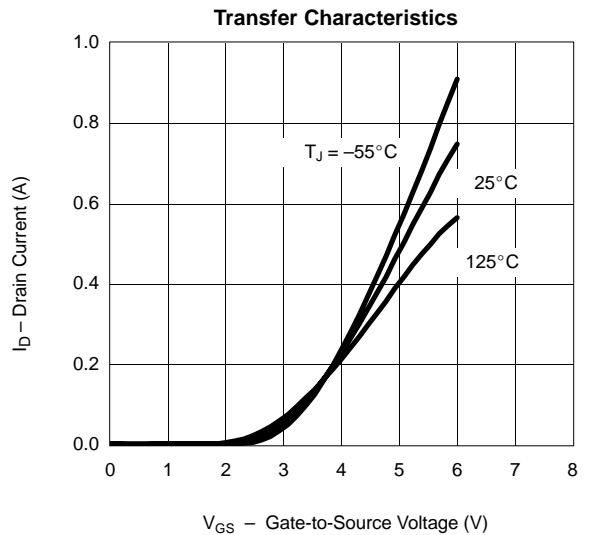
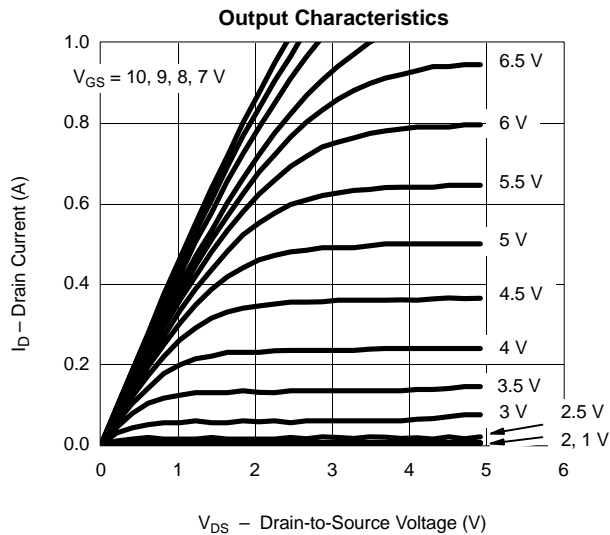



**TYPICAL CHARACTERISTICS ( $T_A = 25^\circ\text{C}$  UNLESS OTHERWISE NOTED)**

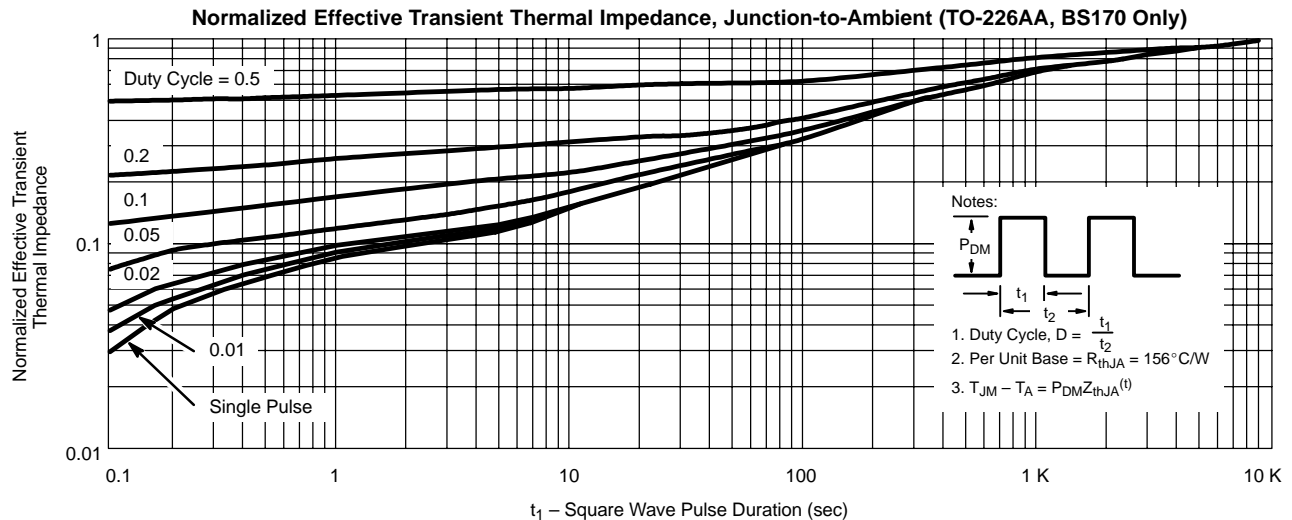
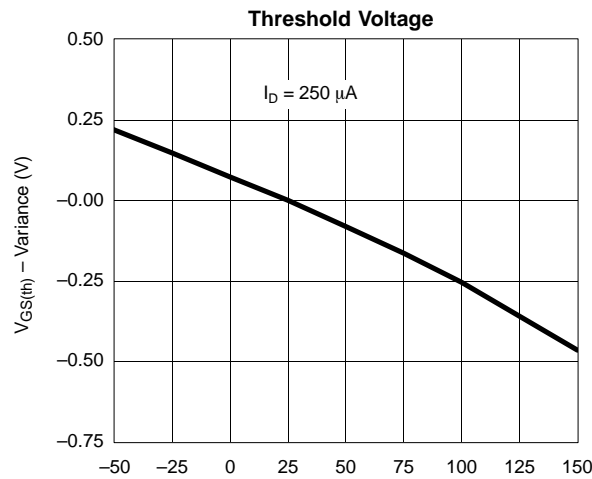
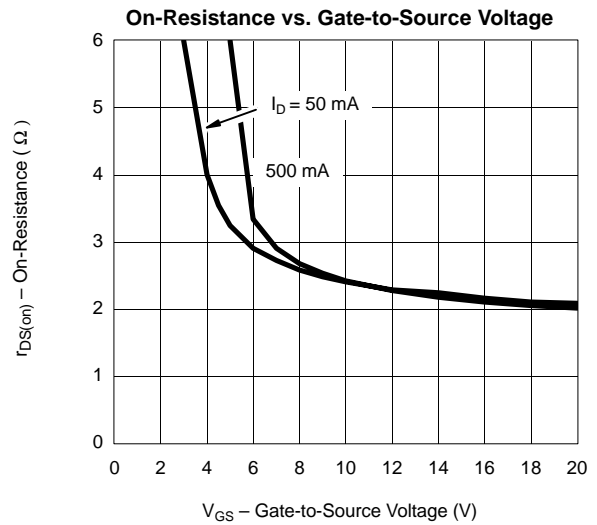
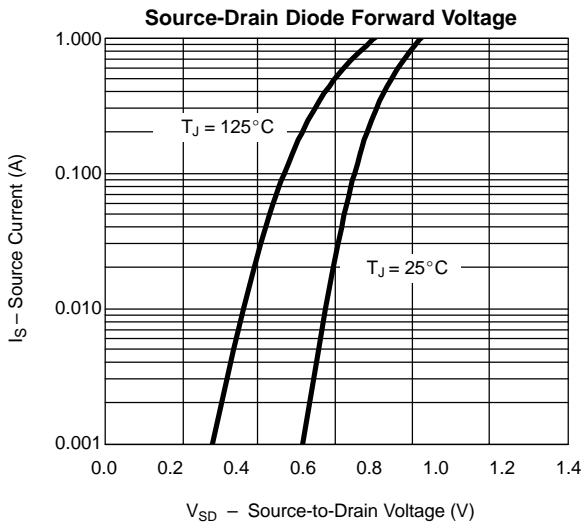



## Disclaimer

All product specifications and data are subject to change without notice.

Vishay Intertechnology, Inc., its affiliates, agents, and employees, and all persons acting on its or their behalf (collectively, "Vishay"), disclaim any and all liability for any errors, inaccuracies or incompleteness contained herein or in any other disclosure relating to any product.

Vishay disclaims any and all liability arising out of the use or application of any product described herein or of any information provided herein to the maximum extent permitted by law. The product specifications do not expand or otherwise modify Vishay's terms and conditions of purchase, including but not limited to the warranty expressed therein, which apply to these products.

No license, express or implied, by estoppel or otherwise, to any intellectual property rights is granted by this document or by any conduct of Vishay.

The products shown herein are not designed for use in medical, life-saving, or life-sustaining applications unless otherwise expressly indicated. Customers using or selling Vishay products not expressly indicated for use in such applications do so entirely at their own risk and agree to fully indemnify Vishay for any damages arising or resulting from such use or sale. Please contact authorized Vishay personnel to obtain written terms and conditions regarding products designed for such applications.

Product names and markings noted herein may be trademarks of their respective owners.