

DESCRIPTION The 2SA1175 is designed for use in driver stage of AF amplifier.

- FEATURES**
- High h_{FE} and excellent linearity : 200 TYP.
 h_{FE} ($I_C = -1.0$ mA)
 - Complementary to the NEC 2SC2785 NPN transistor.

ABSOLUTE MAXIMUM RATINGS

- Maximum Temperatures
- Storage Temperature -55 to $+150$ °C
 - Junction Temperature $+150$ °C Maximum
- Maximum Power Dissipation ($T_a = 25$ °C)
- Total Power Dissipation 250 mW
- Maximum Voltages and Currents ($T_a = 25$ °C)
- V_{CBO} Collector to Base Voltage -60 V
 - V_{CEO} Collector to Emitter Voltage -50 V
 - V_{EBO} Emitter to Base Voltage -5.0 V
 - I_C Collector Current -100 mA
 - I_B Base Current -20 mA

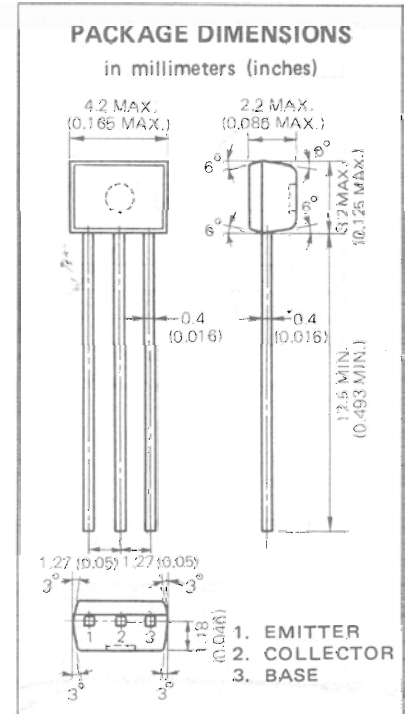

ELECTRICAL CHARACTERISTICS ($T_a = 25$ °C)

SYMBOL	CHARACTERISTIC	MIN.	TYP.	MAX.	UNIT	TEST CONDITIONS
h_{FE}	DC Current Gain	110	200	600	—	$V_{CE} = -6.0$ V, $I_C = -1.0$ mA
NF	Noise Figure		6.0	20	dB	$V_{CE} = -6.0$ V, $I_C = -0.3$ mA, $R_G = 10$ k Ω , $f = 100$ Hz
f_T	Gain Bandwidth Product	50	180		MHz	$V_{CE} = -6.0$ V, $I_E = -1.0$ mA
C_{ob}	Output Capacitance		4.5	6.0	pF	$V_{CB} = -10$ V, $I_E = 0$, $f = 1.0$ MHz
I_{CBO}	Collector Cutoff Current			-0.1	μ A	$V_{CB} = -60$ V, $I_E = 0$
I_{EBO}	Emitter Cutoff Current			-0.1	μ A	$V_{EB} = -5.0$ V, $I_C = 0$
V_{BE}	Base to Emitter Voltage	-0.55	-0.62	-0.65	V	$V_{CE} = -6.0$ V, $I_C = -1.0$ mA
$V_{CE(sat)}$	Collector Saturation Voltage	-0.18	-0.3		V	$I_C = -100$ mA, $I_B = -10$ mA

Classification of h_{FE}

Rank	RF	JF	HF	FF	EF	KF
Range	110 - 180	135 - 220	170 - 270	200 - 320	250 - 400	300 - 600

h_{FE} Test Conditions: $V_{CE} = -6.0$ V, $I_C = -1.0$ mA

TYPICAL CHARACTERISTICS ($T_a = 25^\circ\text{C}$ unless otherwise noted)

TOTAL POWER DISSIPATION vs. AMBIENT TEMPERATURE

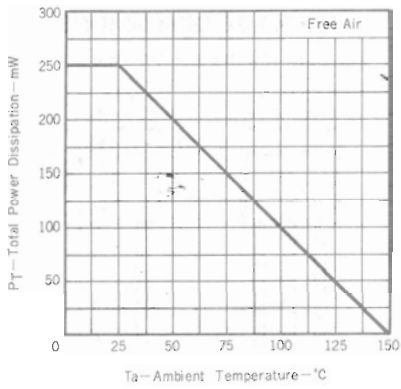

COLLECTOR CURRENT vs. COLLECTOR TO EMITTER VOLTAGE

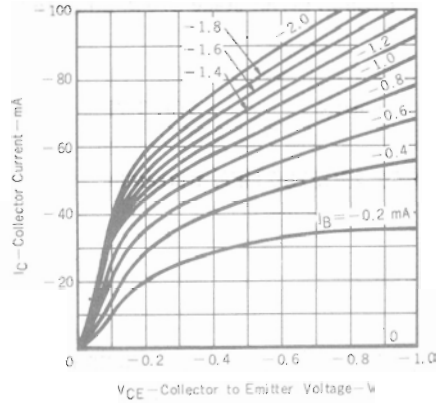

COLLECTOR CURRENT vs. COLLECTOR TO EMITTER VOLTAGE

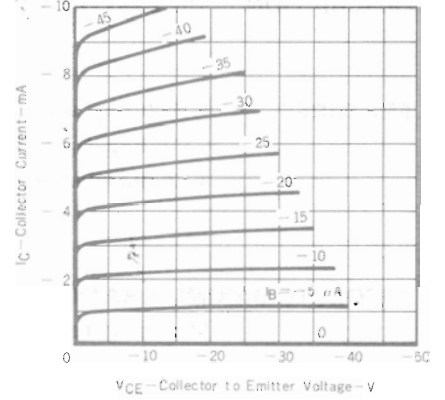

DC CURRENT GAIN vs. COLLECTOR CURRENT

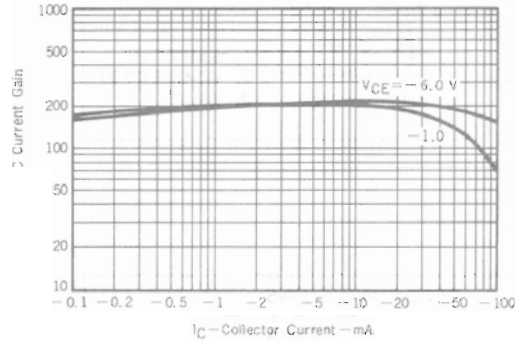

DC CURRENT GAIN vs. COLLECTOR CURRENT

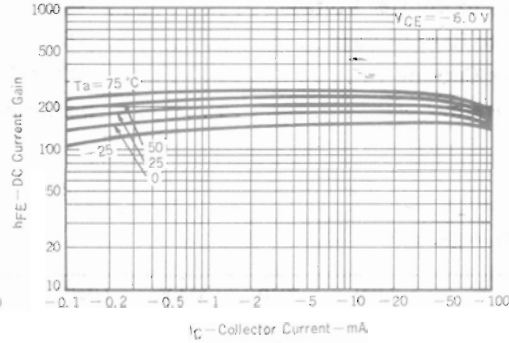

COLLECTOR CURRENT vs. BASE TO EMITTER VOLTAGE

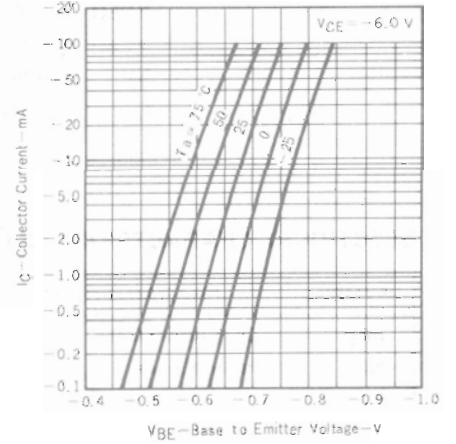

COLLECTOR AND BASE SATURATION VOLTAGE vs. COLLECTOR CURRENT

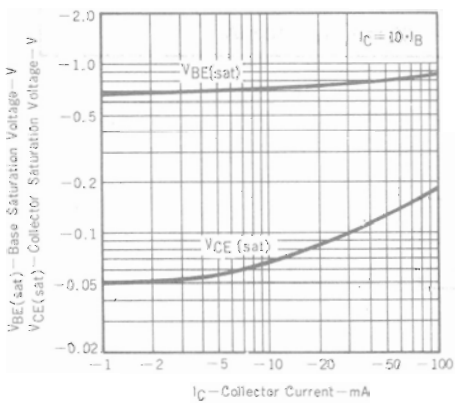

GAIN BANDWIDTH PRODUCT vs. EMITTER CURRENT

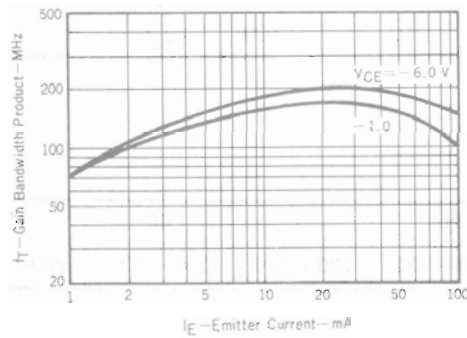

OUTPUT CAPACITANCE vs. REVERSE VOLTAGE

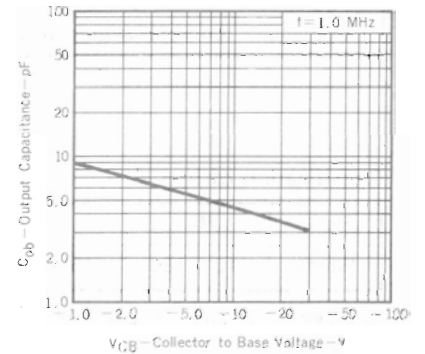

NORMALIZED h-PARAMETERS vs. EMITTER CURRENT

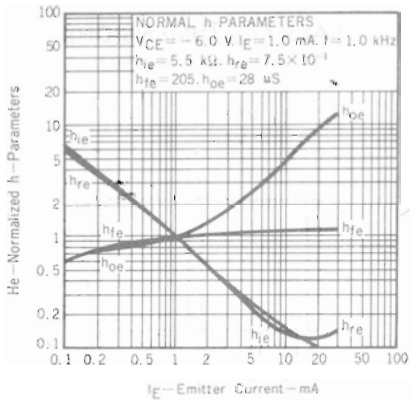

NORMALIZED h-PARAMETERS vs. COLLECTOR TO EMITTER VOLTAGE

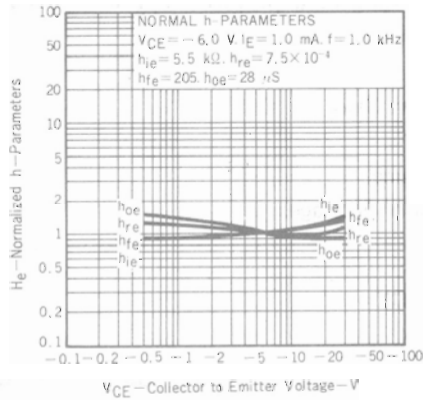

NOISE FIGURE MAP 1

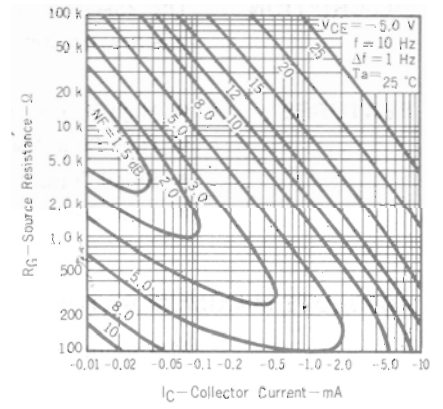

NOISE FIGURE MAP 2

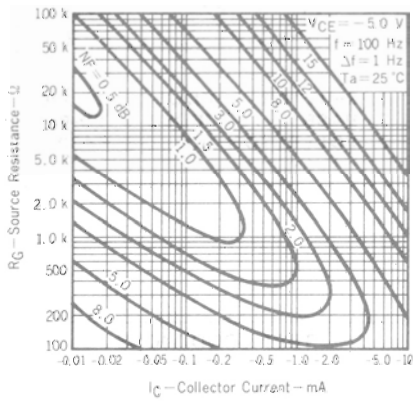

NOISE FIGURE MAP 3

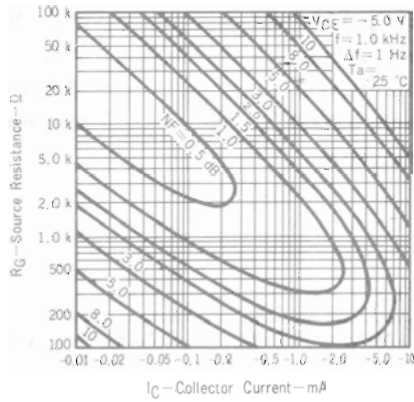

NOISE FIGURE MAP 4

